

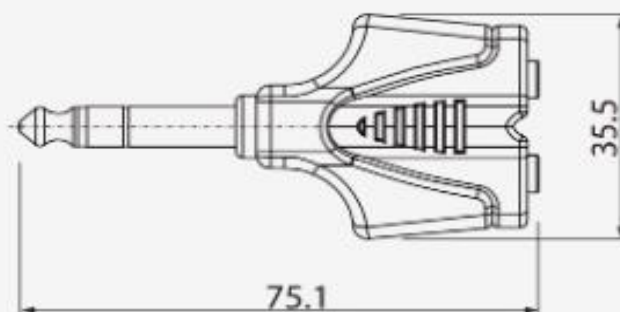

ENGINEERING DRAWING:

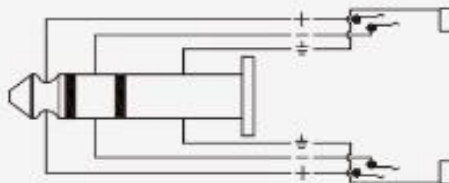

WIRING DIAGRAM:



RPAN340

ELABORO	REVISO	AUTORIZO	COPIA CONTROLADA	PAGINA
			No.	1 de 1

